

HYE boom LIFT 180

AERIAL PLATFORM



Building No. 22, J. K. Industrial Park
Dhamatvan, Ahmedabad
Gujarat
PIN Code: 382435



Reach New Heights with
HYE boom LIFT
Power, Precision, Performance



HYE boom LIFT 180

AERIAL PLATFORM

Fibreglass basket.

Engine Start/Stop control from basket

Kit mountable on chassis from 5 ton GVW.

Telescopic boom (2 elements) (main boom + 2 telescopic extension) – fully hydraulic platform.

360° Non-continuous turret rotation on bearing turntable.

4 hydraulic outriggers.

230V AC electric socket in the basket.

Proportional hydraulic controls in the basket.

Hydraulics components from European origin.

Turret control station equipped with manual lever control.

60° Right + 60° Left rotating basket.

Automatic basket levelling by hydraulic parallelogram.



Building No. 22, J. K. Industrial Park
Dhamatvan, Ahmedabad
Gujarat
PIN Code: 382435





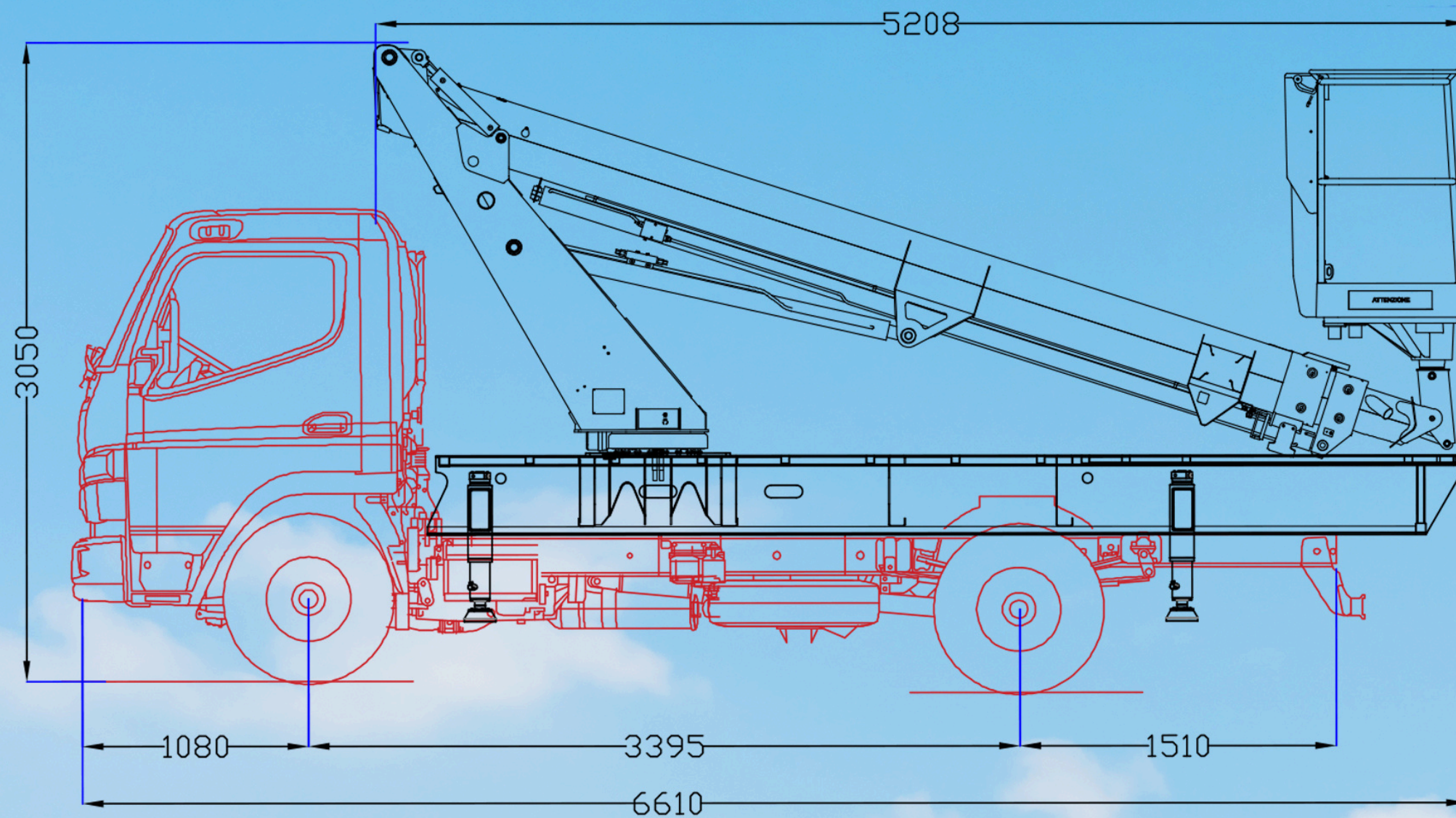

HYE boom LIFT 180

AERIAL PLATFORM

SPECIFICATION



-  **18 m***
-  **250 kg**
-  **1400x700x1100 mm**
-  **9 m***
-  **16 m**
- GW min 5 t**

***outreach and height max values and repeatability can change within $\pm 3\%$ due to manufacturing variation and working condition**

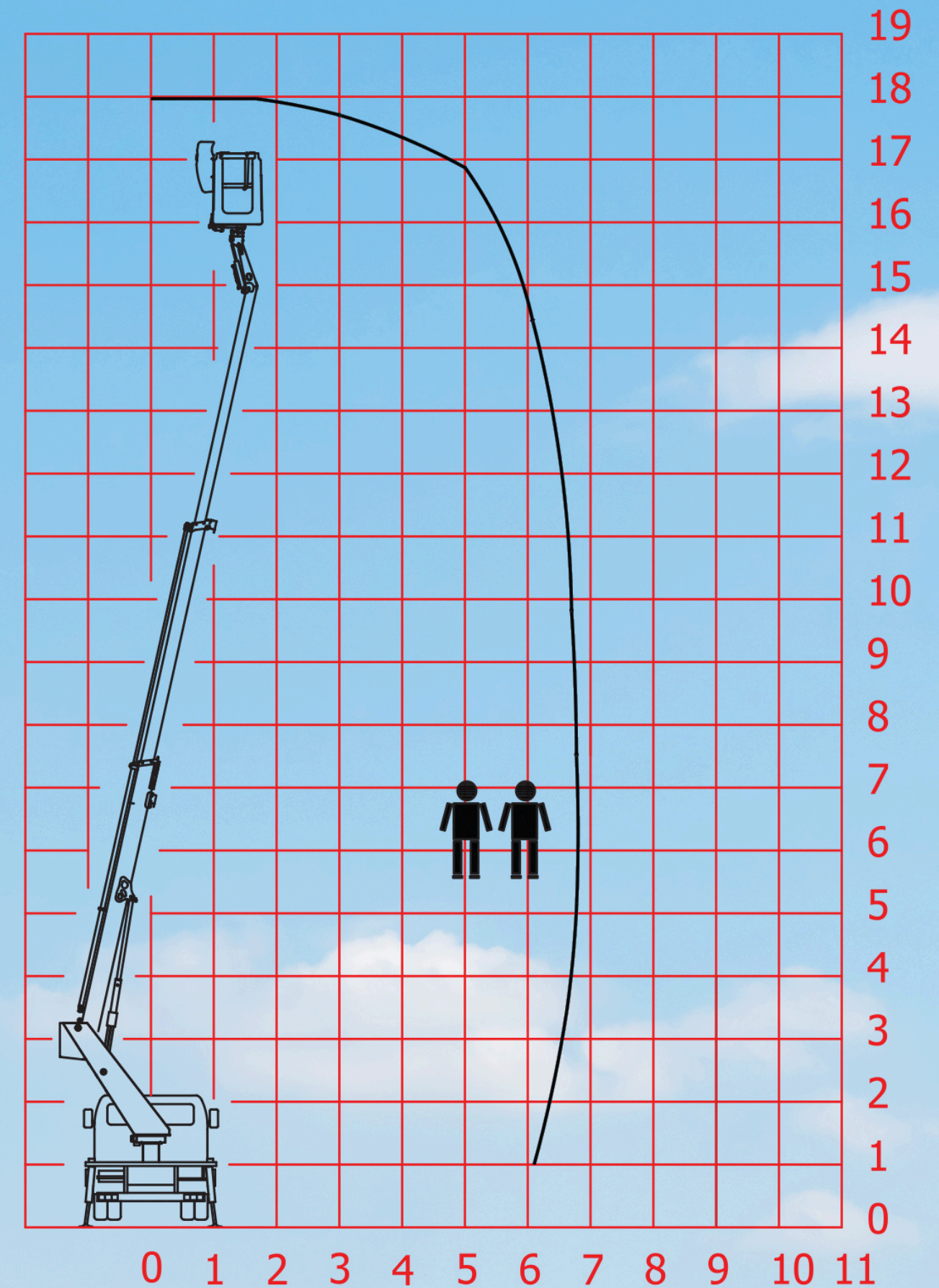

Building No. 22, J. K. Industrial Park
Dhamatvan, Ahmedabad
Gujarat
PIN Code: 382435